

Pilot-Scale Silicone Process for Low-Cost CO₂ Capture

GE Global Research



GE Global
Research

Benjamin Wood



DOE Award: DE-FE0013755

2014 NETL CO₂ Capture
Technology Meeting
July 30, 2014

Overview

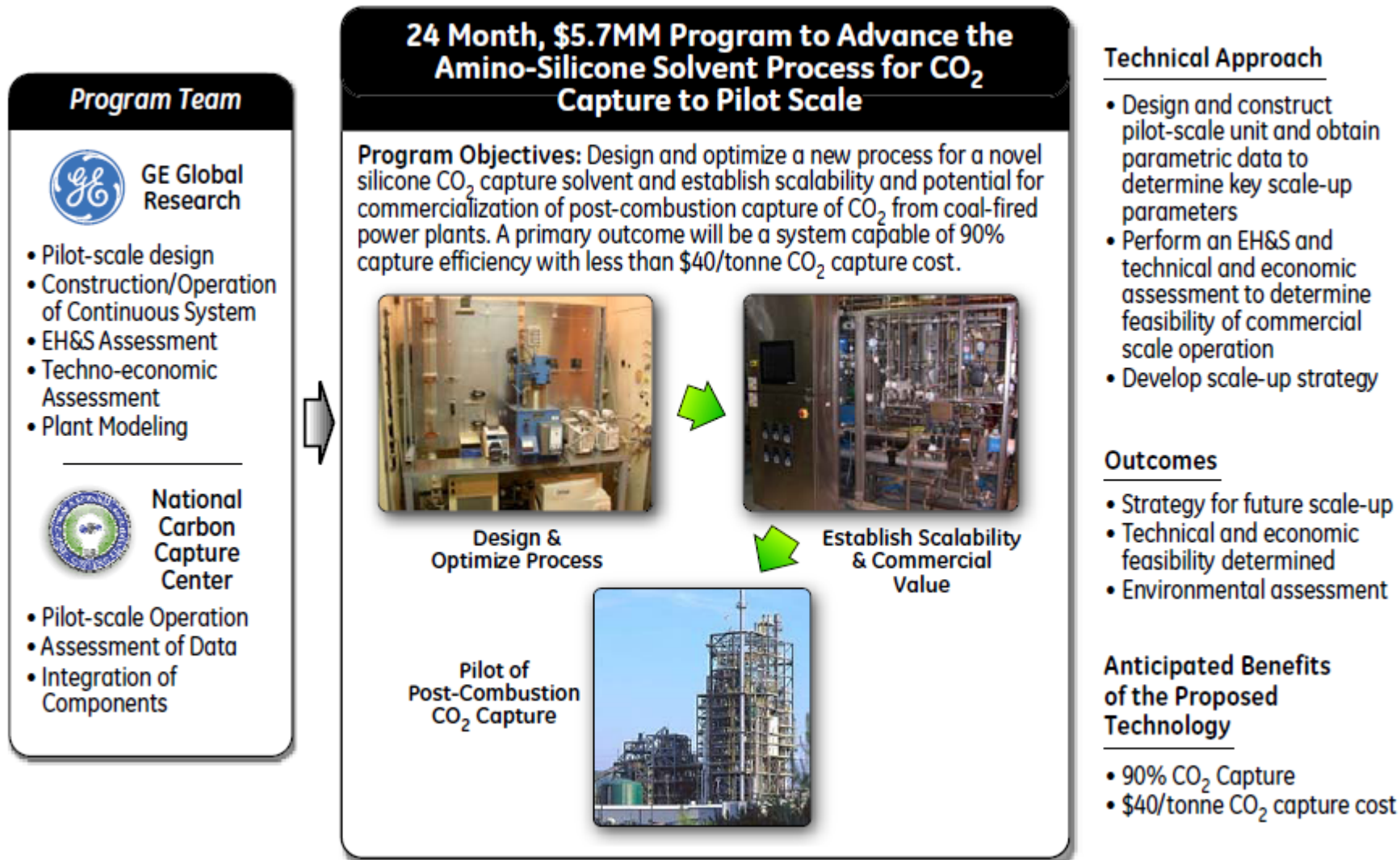

Scope

This two-year project is divided into two phases.

Phase I: 1/1/2014 - 12/31/2014

(\$1.5MM with 20% GE cost share)

- Develop preliminary process models and perform preliminary techno-economic analysis
- Perform preliminary EH&S risk assessment
- Design pilot-scale system and construct components

Phase II: 1/1/2015 - 12/31/2015

(\$4.2MM with 20% GE cost share)

- Integrate aminosilicone specific components with the NCCC pilot-scale system
- Obtain and analyze engineering data from pilot tests at 0.5 MW scale
- Perform techno-economic analysis and update cost of carbon capture
- Develop scale-up strategy
- Perform technology EH&S risk assessment
- Develop cost estimate for full-scale manufacture of solvent

Aminosilicone Absorbent

GAP-X (Liquid)

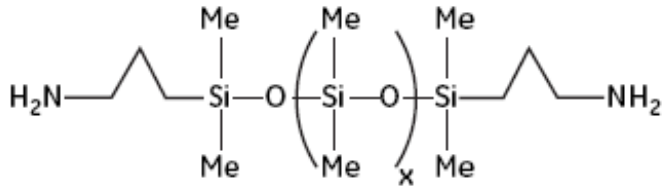

GAP-X Carbamate (Solid)

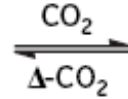
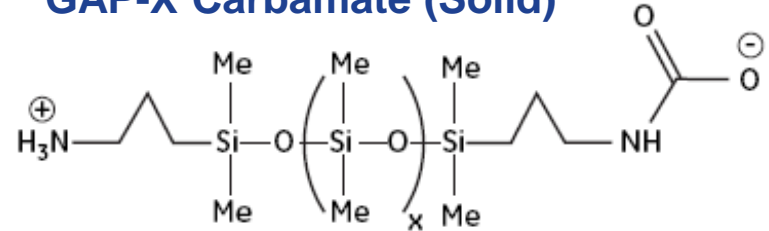

GAP-1_m Absorbent Composition

- 40% GAP-0
- 33% GAP-1
- 19% GAP-2
- 8% GAP-3

Carbamate does not precipitate in a 60/40 (wt/wt) GAP-1_m/TEG mixture

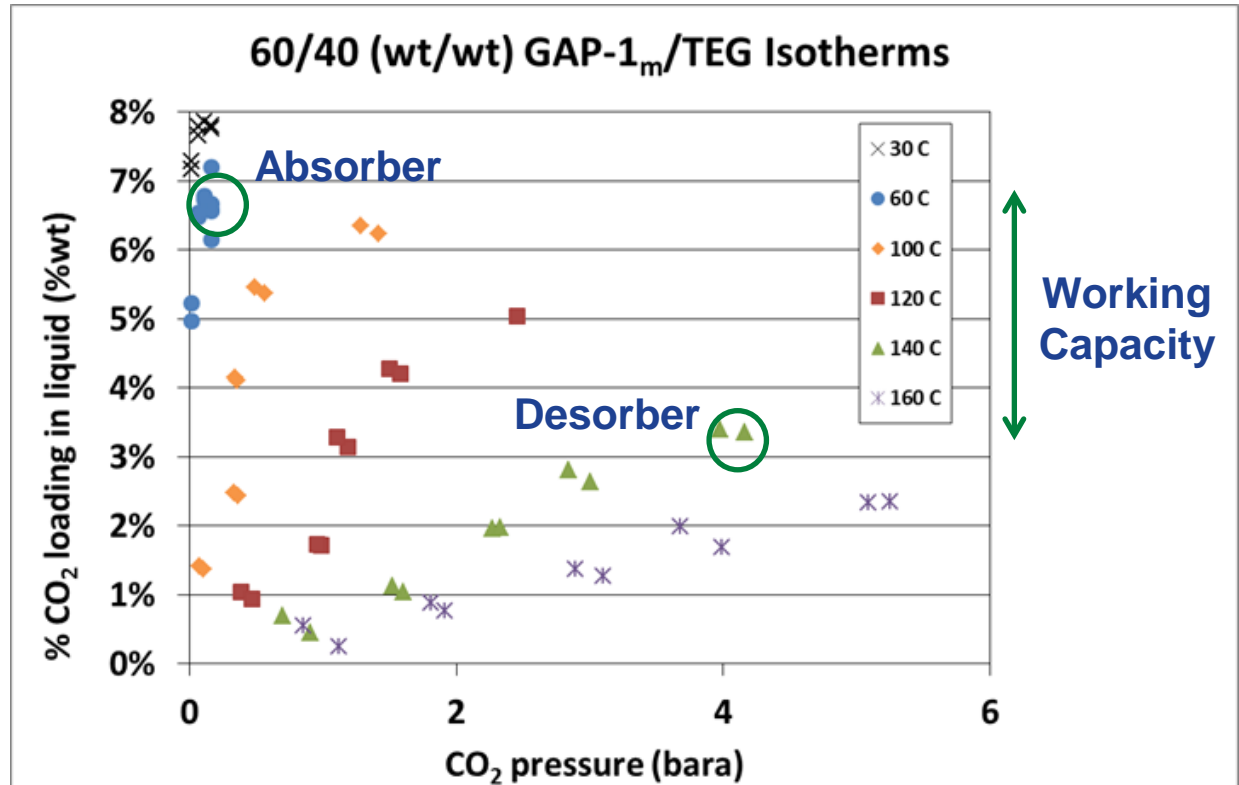

Summary of Aminosilicone Advantages

- Higher thermal stability (higher desorption T/greater capture capacity and/or pressure)
- Lower volatility
 - Simplified separations
 - Less energy wasted vaporizing solvent and/or water
 - Lower airborne release rates
- Lower heat capacity
- Reduced corrosion
- Ability to remove water (useful in adjacent industries)
- Potentially decreased issues with aerosol formation

Challenges

- High viscosity (at low T and high loading)
- Higher heat of reaction
- Solvent cost

Bench-Scale Schematic

Full Automation

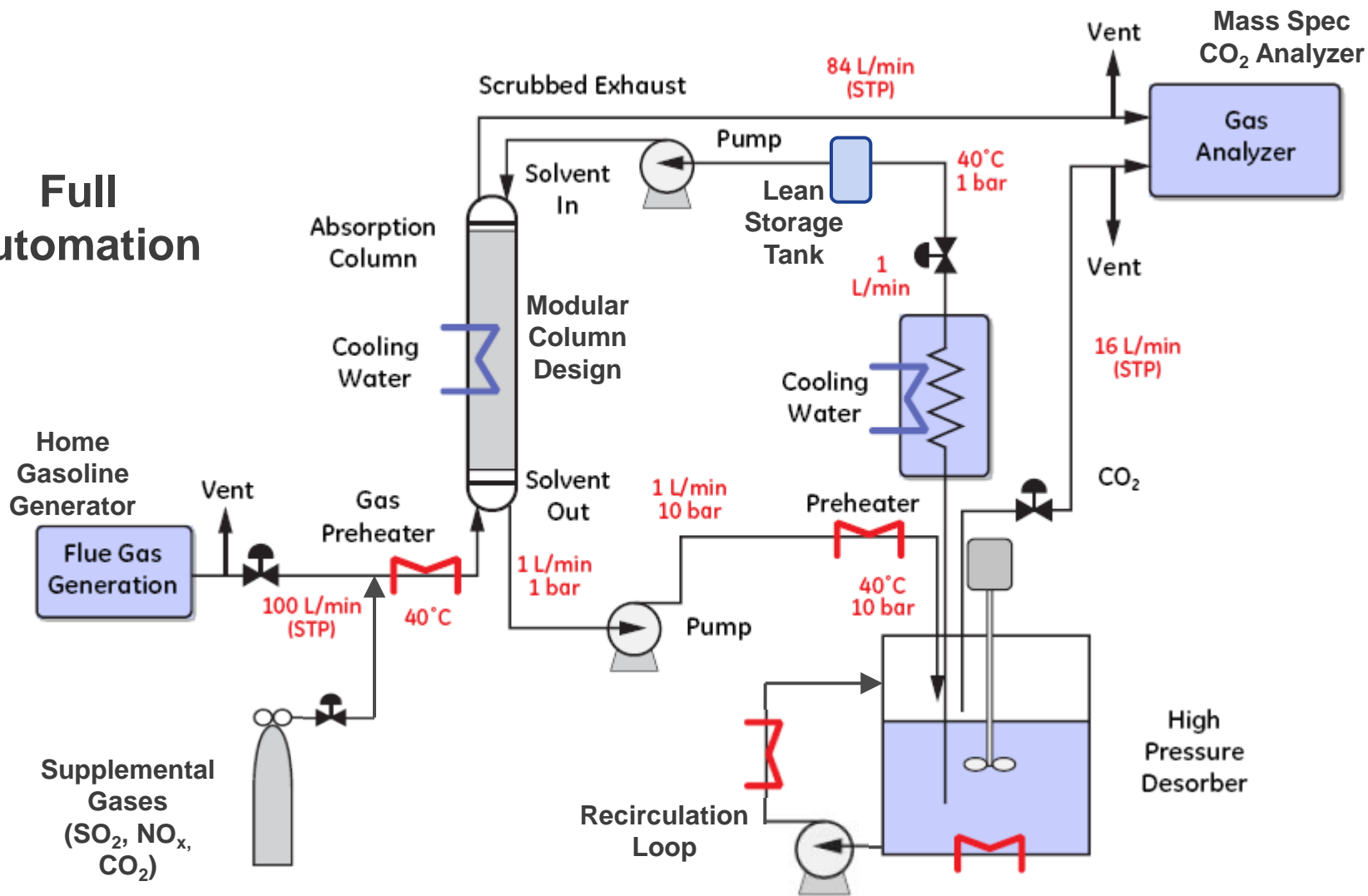

Bench-Scale CO₂-Capture System



Absorber Column



Recycle Loop
Heat Exchanger

Desorber

Bench-Scale System Tests

The effect of varying liquid and gas flow rates on CO₂ capture were studied.

Parameter	Units	Value
Desorber temperature	°C	160
Desorber agitator speed	RPM	300
Desorber recirculation loop pump speed	% of max	50
Desorber level	in H ₂ O	7.5
Desorber pressure	psig	0
Inlet absorber temperature (gas and liquid)	°C	40
Absorber sump level	in H ₂ O	5.0
CO ₂ concentration in inlet gas to column	mol%	16
Gas source		bottled

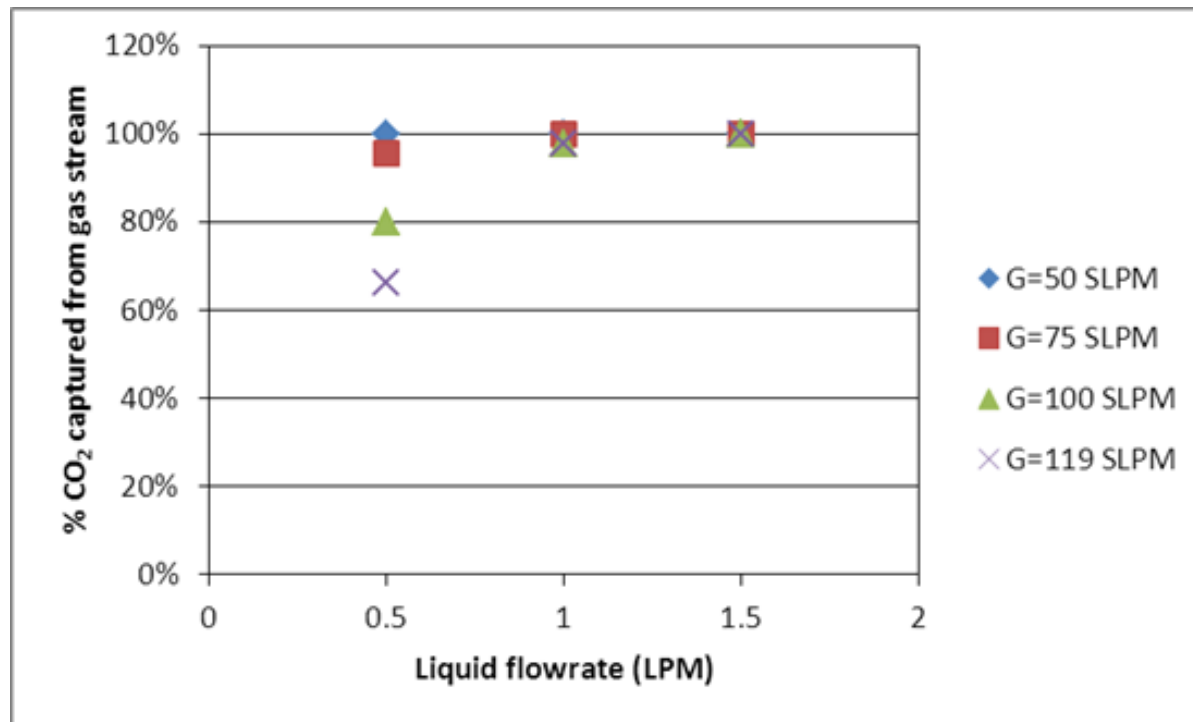

Process Modeling

- Data from the bench-scale system were used to tune bench-scale carbon-capture model in ASPEN Plus
 - Model scaled up to pilot- and 550 MW commercial-scale
- Process modeling of the coal-fired power plant was performed in Thermoflow by GE Power and Water
 - Model without carbon capture was tuned to match Case 11 from Bituminous Baseline Study
- Power plant model and carbon capture model were integrated

ASPEN Plus Model of Carbon-Capture System

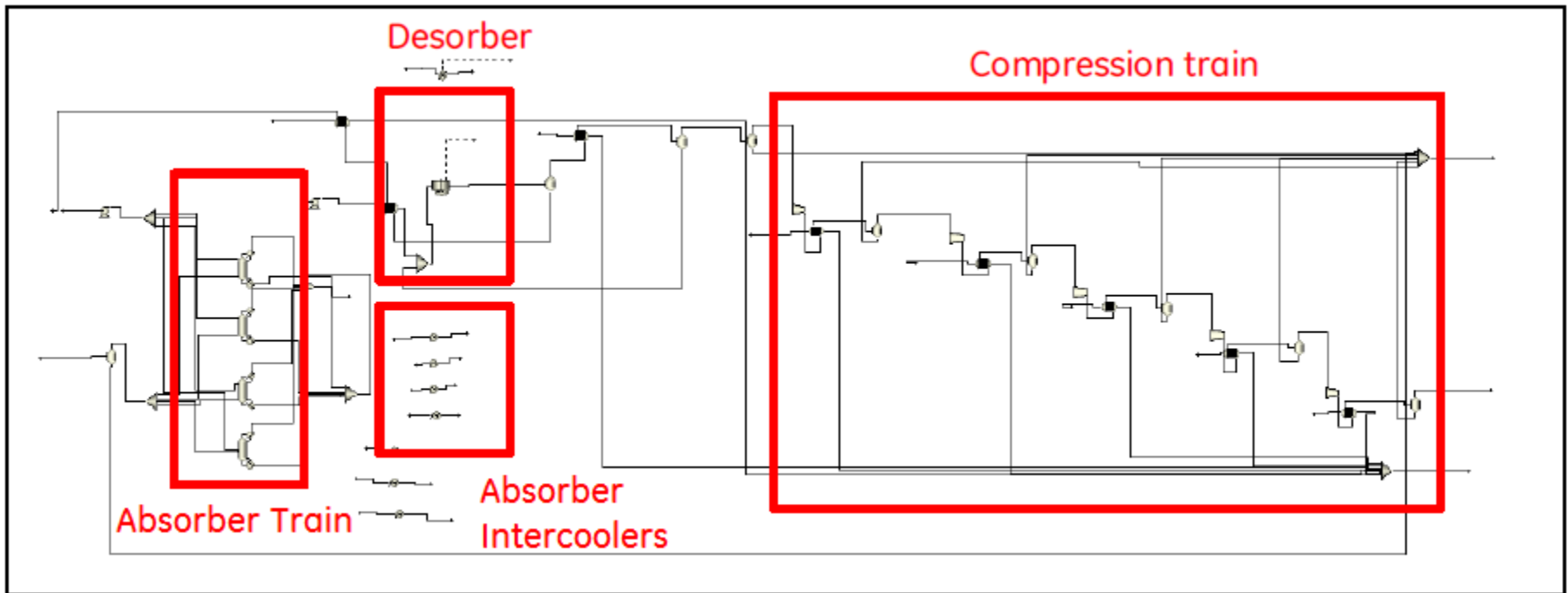

Plant Efficiency

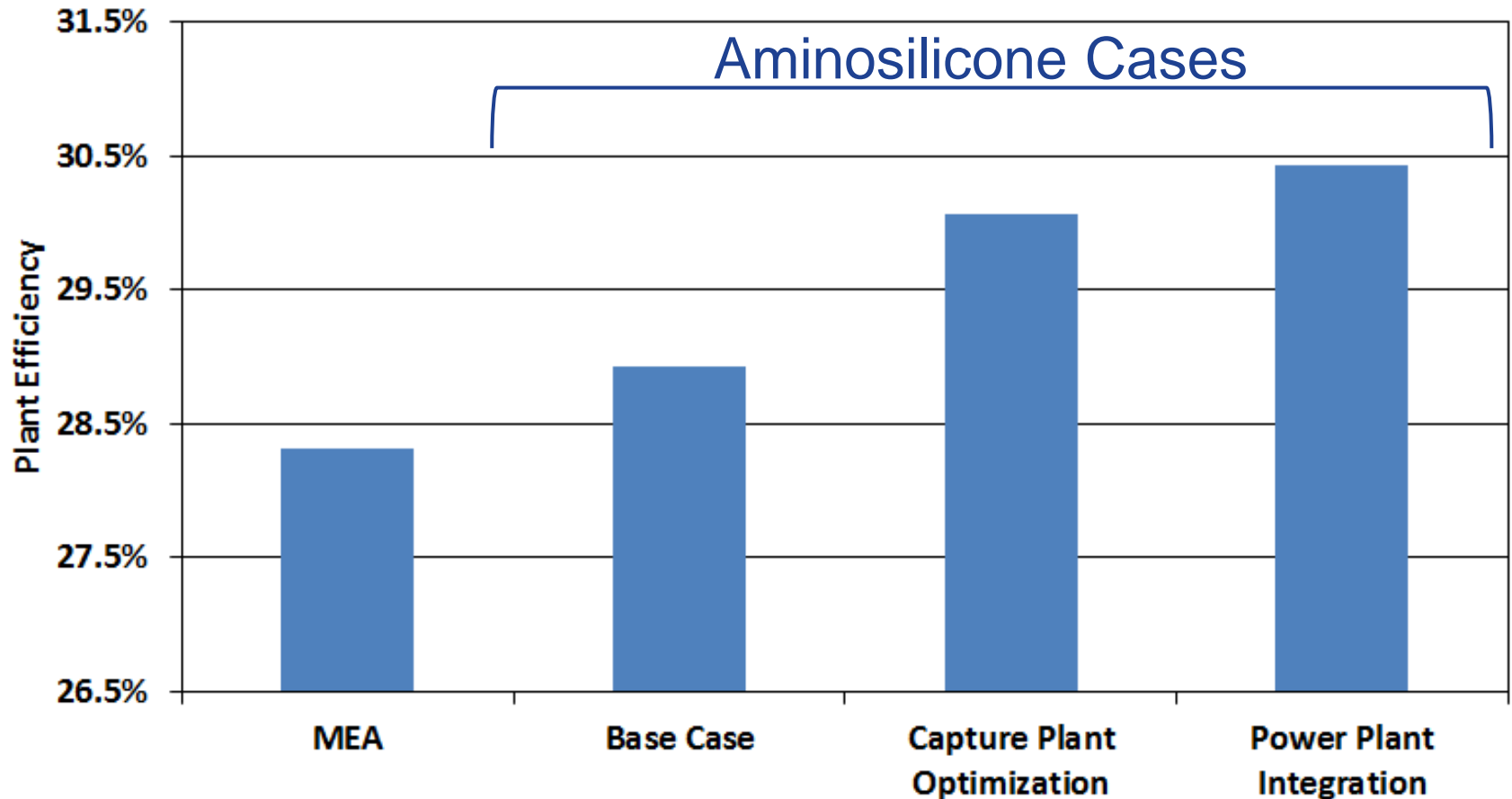

- Base Case – Desorber at 140 °C and 4 bar(a)
- Capture Plant Optimization - Optimization of desorber T, absorber column intercoolers, packing type, etc.
- Power Plant Integration – Cooling water integration and waste heat recovery

First Year Removal Cost of CO₂

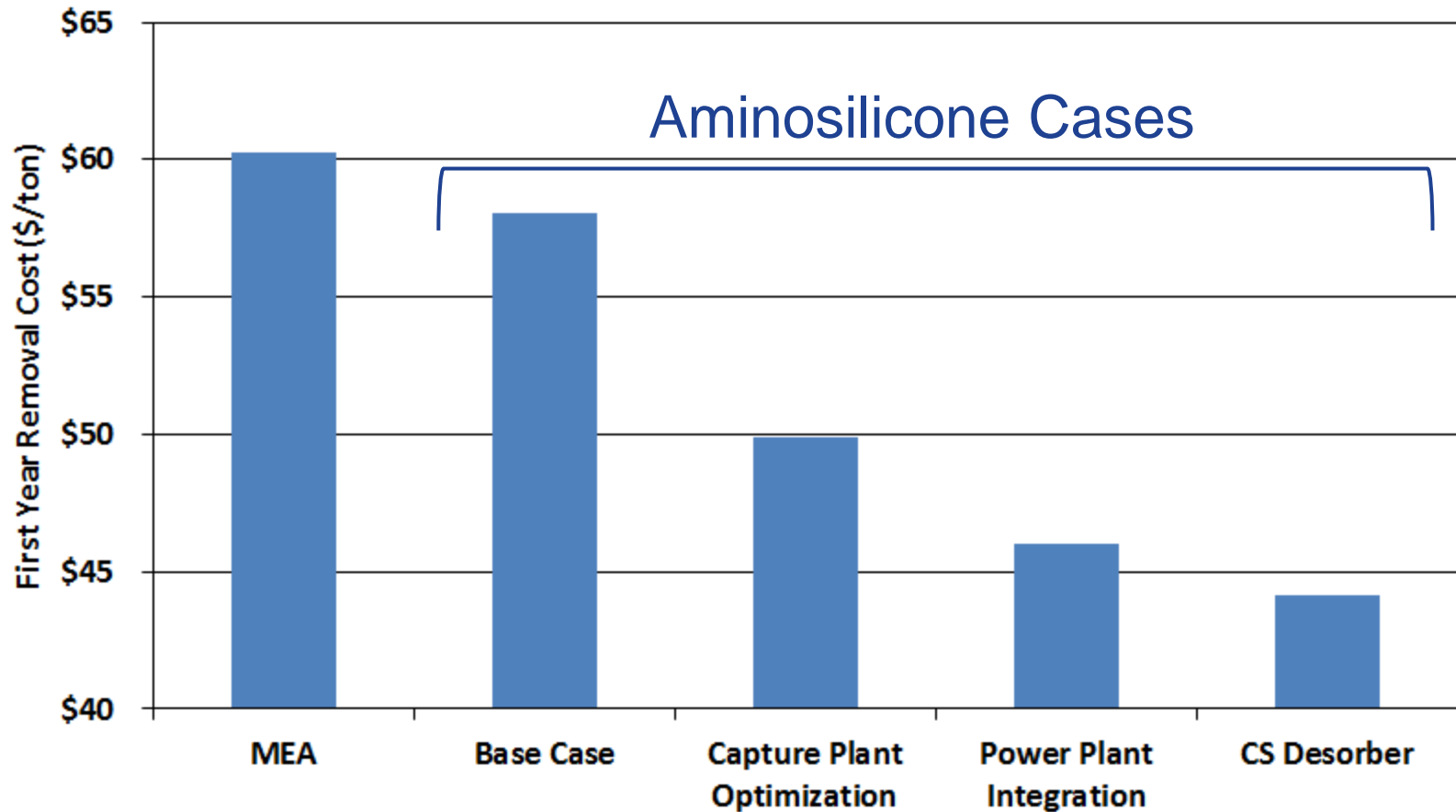

Pilot-Scale Process

CO₂-capture process for pilot-scale

The NCCC PSTU

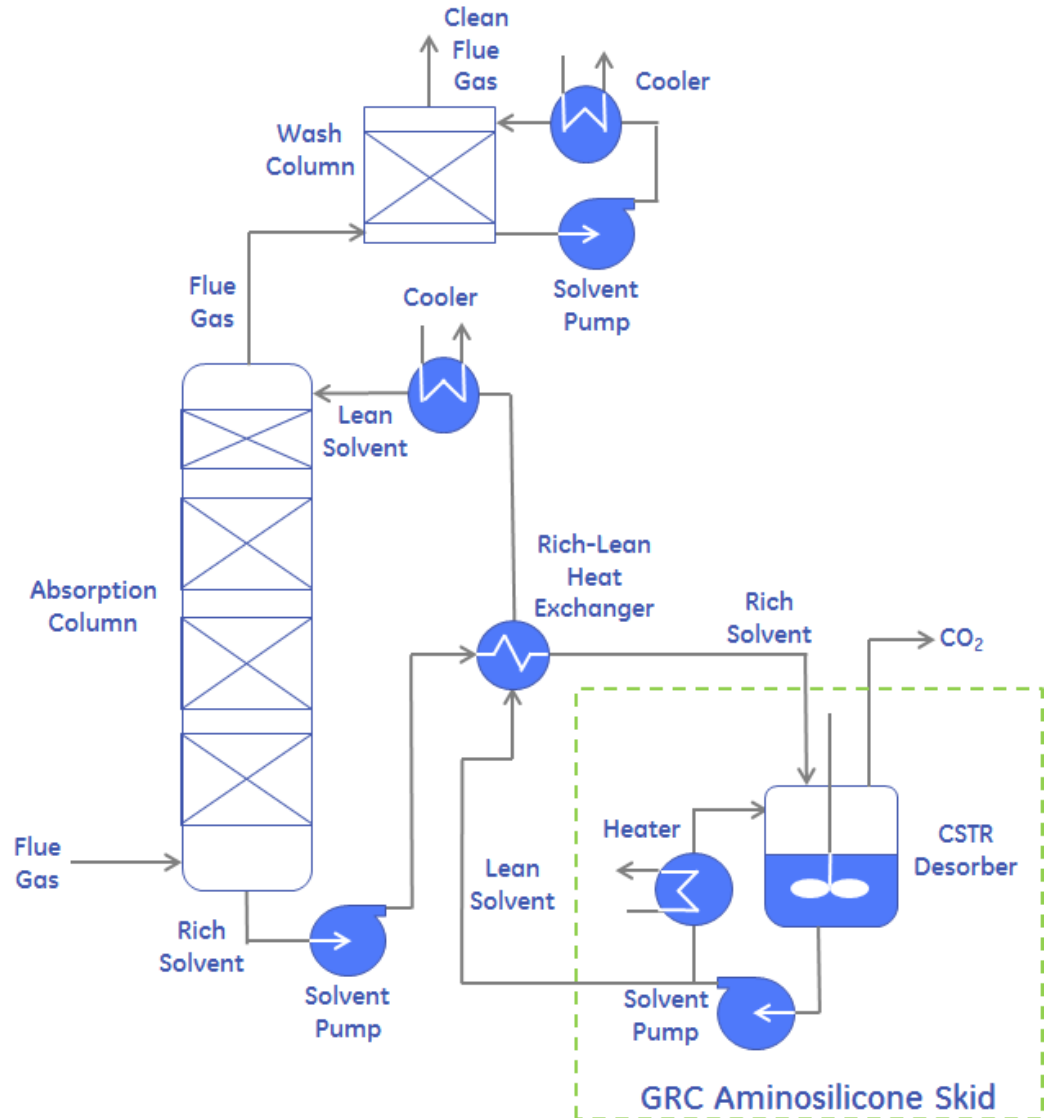

Skid Design

- Basic Engineering Package Completed
 - Detailed P&IDs
 - Initial designs/specs for major equipment
 - Material and energy balances
- Working with the NCCC
 - Kick-off meeting in first quarter of 2014
 - Transmitted Basic Engineering Package (Tier 1 information)
 - Conducted Preliminary Hazard Review

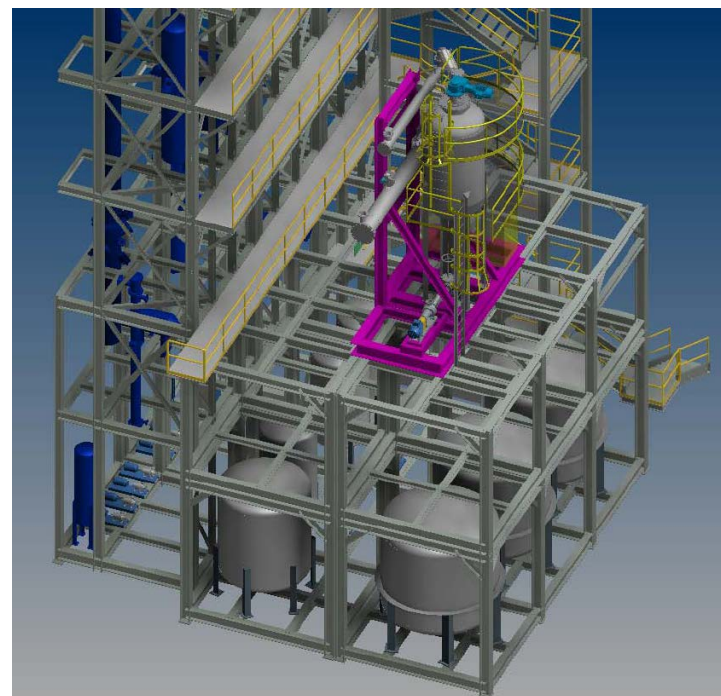
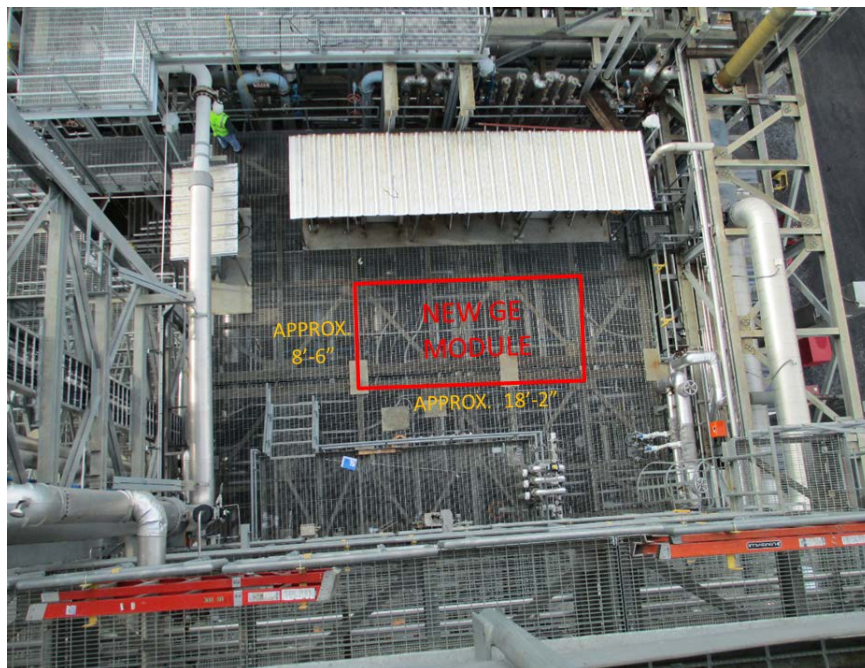

Future Work

- Remainder of 2014
 - Complete detailed design of skid
 - Fabricate skid for delivery at the NCCC early next year
 - Perform preliminary EH&S Risk Assessment
- 2015
 - Integrate skid with PSTU at the NCCC
 - Perform tests (~3 months)
 - Use data to update process models
 - Update Techno-Economic Analysis and EH&S Risk Assessment
- Beyond
 - Determine next scale for testing
 - Consider adjacent applications with intermediate scale
 - Look for partners
 - Test site
 - Solvent manufactures
 - Need to grow solvent supply

Thanks

- Andrew O’Palko (program manager)
- Lynn Brickett
- GE GRC team members
- GE Power and Water
- The National Carbon Capture Center

Acknowledgment: This material is based upon work supported by the Department of Energy under Award Number DE-FE0013755.

Disclaimer: This report was prepared as an account of work sponsored by an agency of the United States Government. Neither the United States Government nor any agency thereof, nor any of their employees, makes any warranty, express or implied, or assumes any legal liability or responsibility for the accuracy, completeness, or usefulness of any information, apparatus, product, or process disclosed, or represents that its use would not infringe privately owned rights. Reference herein to any specific commercial product, process, or service by trade name, trademark, manufacturer, or otherwise does not necessarily constitute or imply its endorsement, recommendation, or favoring by the United States Government or any agency thereof. The views and opinions of authors expressed herein do not necessarily state or reflect those of the United States Government or any agency thereof.